

Jammy

Pylväsvalaisin

Stolplykta

Lamp Post

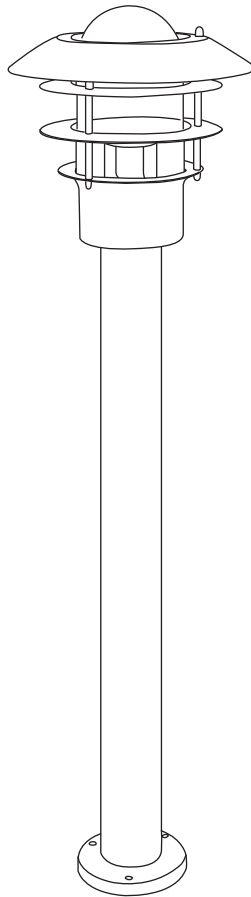

ASENNUSOHJE
INSTALLATIONSANVISING
INSTRUCTION MANUAL

Art. nr / Typ. Nr.

O-0005-P-BL

O-0005-P-WH

Suomi

Svenska

English



Ver. 201601

Suomi Svenska English



Noudata ohjeita tarkasti ja säilytä käyttöohje myöhempää tarvetta varten.

ASENNUS

Katso alla olevat kuvat.

Suomi Svenska English



Läs bruksanvisningen noga innan installationen påbörjas och spara den för senare tillfälle.

INSTALLATION

Se bif. ritningar.

Suomi Svenska English



Read this instruction carefully before commencing the installation keep this safe for future reference.

INSTALLATION

Refer to drawings for explanation.

220-240V ~ 50Hz
Max 60W, E27 x 1

IP44  **CE** 

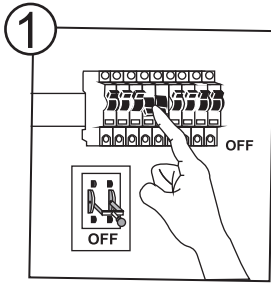

Dräneringshål
Vuotoreikä
Drainage hole

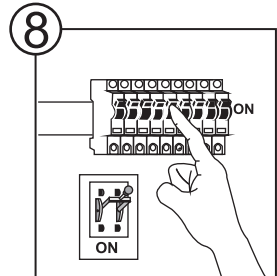
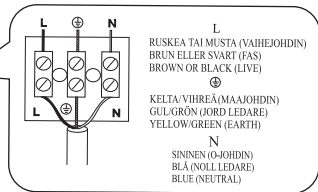
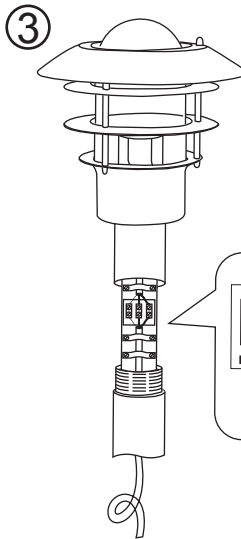
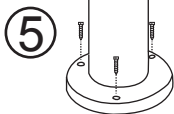
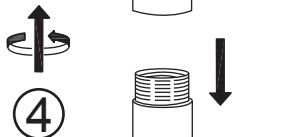
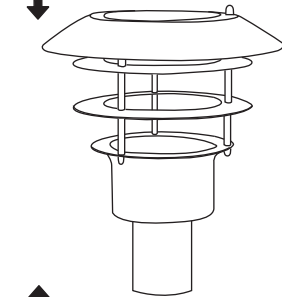
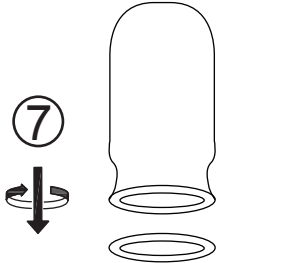
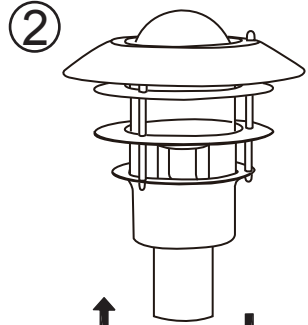

FI

Valaisimen saa asentaa vain sähköalan ammattilainen. Käytä ainoastaan valonlähdettä ja tehoa joka valaisimeen on merkitty. Kytke virta pois päältä ennen asennusta tai huoltoa. Tämä asennusohje on säilytettävä ja sen on oltava käytössä asennuksessa ja huollossa.

SE

Armaturen får endast installeras av en fackman. Använd endast ljuskälla och effekt som är märkta på armaturen. Bryt av strömmen före installation eller service. Denna monteringsanvisning bör sparas och finnas tillgänglig vid installation eller framtida service.

UK

Only a professional electrician is allowed to do the installation. Use only light sources and rated wattages as marked in the luminaire. Switch off the current before installation or service. This mounting instruction must be kept available during installation and for future maintenance.